

# PARTS DRAWINGS

TT4571 RAREBEAR



**AS6291 FRP Fuselage**

FRP Fuselage(1)

Rudder(1)

FRP Opening Cover(1)

FRP Tail Cover(1)

CA Hinge(2)

Rubber Band(1)

2x8mm Washer Wood Screw(22)

Doubler(24)

2.3x12mm Washer Wood Screw(6)

**AS6302 Plywood Parts**

Plywood Parts(A)

Plywood Parts(B)

Plywood Parts(C)

**AS6292 Main Wing**

Left Wing(1)

Right Wing(1)

Aileron Servo Case(L/1, R/1)

FRP Wing Joiner Tube(1)

CA Hinge(6)

Dowel(4)

Air Cooling Inlet(2)

3x16mm Flat Head Wood Screw(8)

2.3x12mm Washer Wood Screw(8)

3x15mm Wood Screw(2)

**AS6293 Horizontal Tail**

Left H.T.(1)

Right H.T.(1)

FRP Tube(1, S)

FRP Tube(1, L)

CA Hinge(4)

**No.3291 Aluminum Spinner (3-blade)**

Al. Spinner(3-blade,1)

Back Plate(1)

Adaptor(1)

Bushing(1)

Spinner Bolt(1)

**OPTIONAL PARTS**

**No.3290 Aluminum Spinner (2-blade)**

Al. Spinner(2-blade,1)

Back Plate(1)

Adaptor(1)

Bushing(1)

Spinner Bolt(1)

**AS6301 Decals**

Decal(A)

Decal(B)

**AS6296 Cowl**

Cowl(1)

2x8mm Washer Wood Screw(6)

### AS6294 Canopy & Cockpit

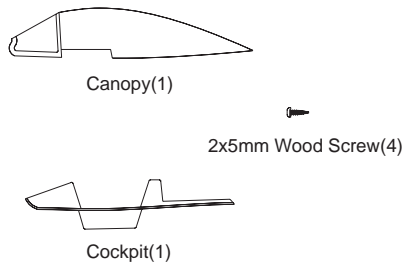

### AS6295 Retract Decoration

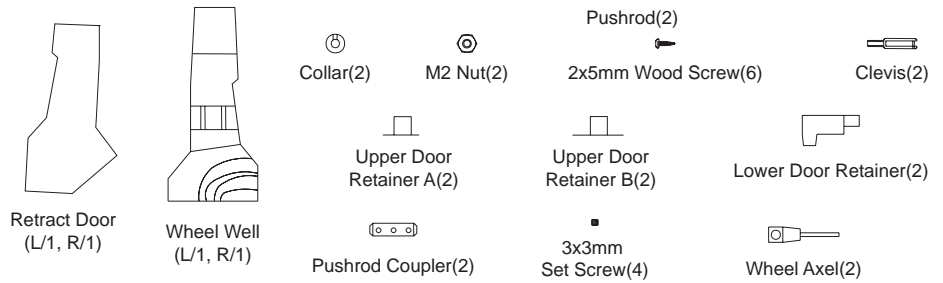

### No. 3015 Scale Tail Gear

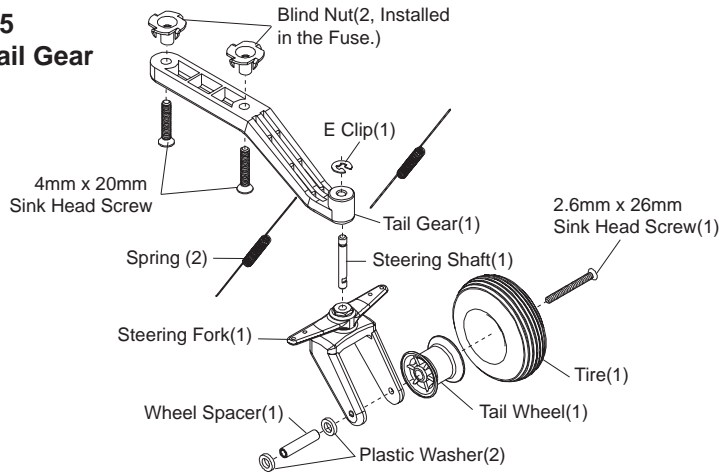

### No. 3265 Fuel Tank

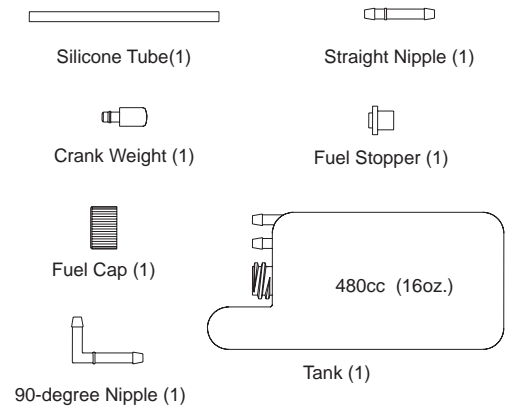

### No.3012 Anti Vibration Engine Mount

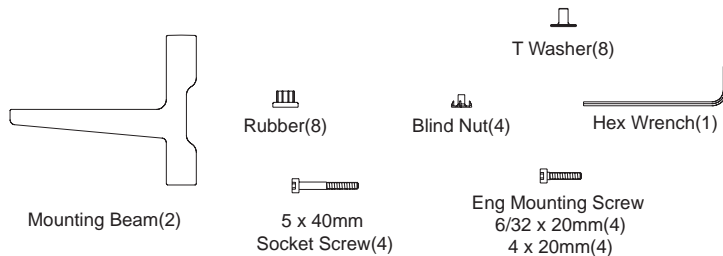

### No.3023 Retract Servo Link

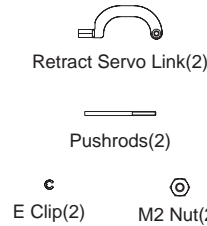

### No.3258 Wheel



### AS6298 Rudder Linkage Set

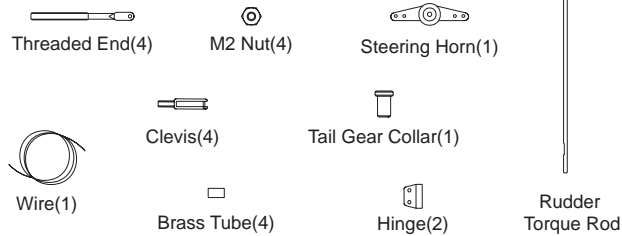

### AS6297 Elevator Linkage Set

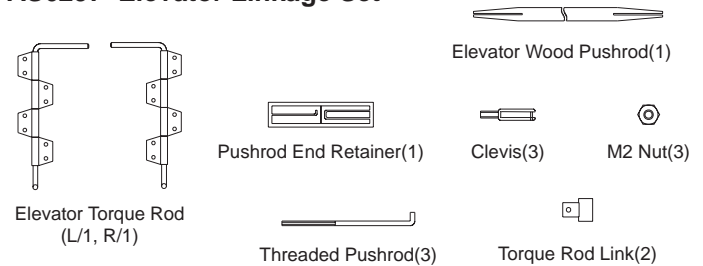

### PE0009 Hardware Set

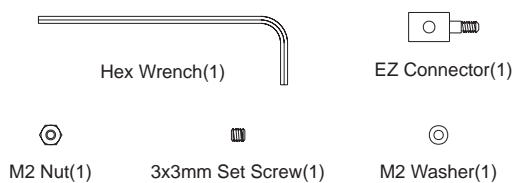

### AS6299 Pushrod Set

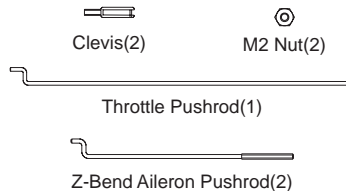

### AS6300 Control Horn

